

1

2

3

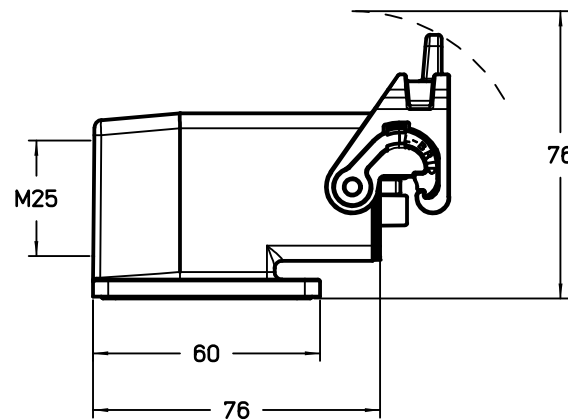
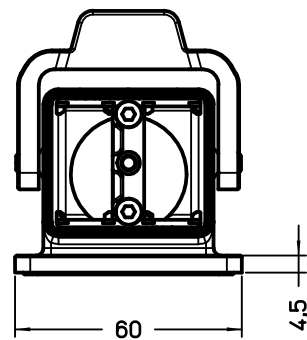
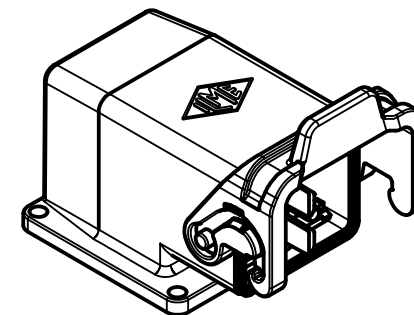
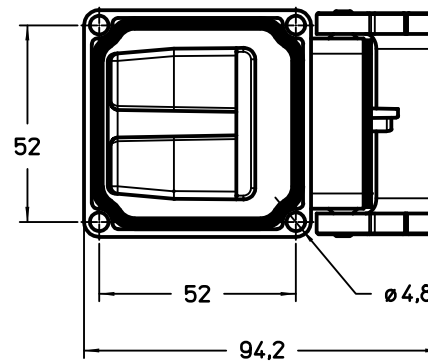
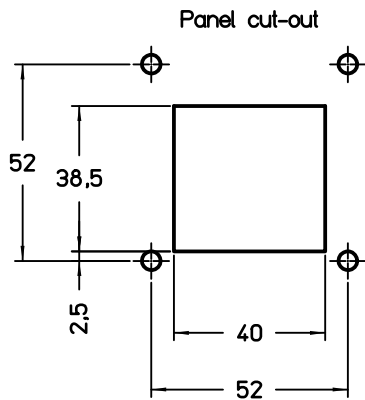

REV.	DATE	SIGNATURE		
Dimensions in mm		Simplified representation with dimensions without tolerance		
Original Size A4		MXA 02 IAP25		Scale 1:2
Date 27/11/23		Angled metal bulkhead mounting housing, 1 lever and gasket		
Sign. S.Diasparra		with open bottom flange, M25 entry		

1

2

3

